

MAX. 0.74in
MIN. 0.66in
[18.9mm]
[16.9mm]
ADJUSTABLE
CCD IMAGE PLANE

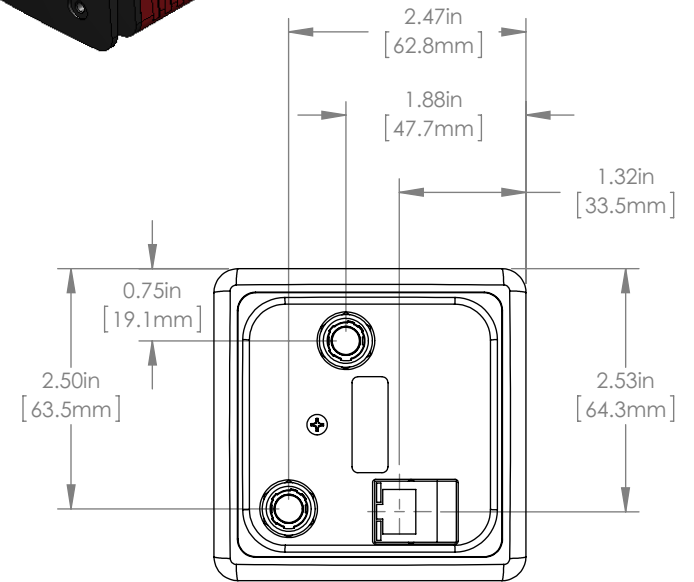
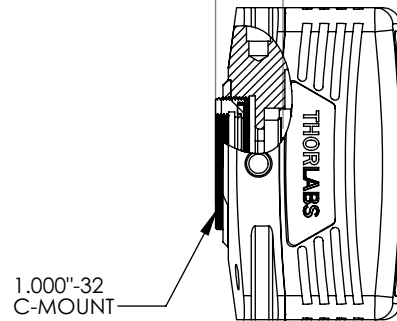

REFER TO USERS MANUAL
FOR INTERCONNECT DETAILS

DRAWING PROJECTION

	NAME	DATE
DRAWN	J.O.	7/23/15
APPROVAL	M.P.	7/23/15

COPYRIGHT © 2015 BY THORLABS

VALUES IN PARENTHESIS ARE CALCULATED
AND MAY CONTAIN ROUND OFF ERRORS

THORLABS
www.thorlabs.com

DIGITAL SCIENTIFIC CAMERA

MATERIAL	N/A	REV A
----------	-----	----------

ITEM #	4070C-GE	APPROX WEIGHT 0.75 kg
--------	----------	--------------------------

FOR INFORMATION ONLY
NOT FOR MANUFACTURING PURPOSES

ROHS COMPLIANT